

Ref: 38.056

Features:

- Protection against transient main peaks up to 1KV (between L and N) and up to 2 KV (between L/N and PE).
- Electrical short-circuit protection
- Protección de sobrecarga
- Protection against “no load” operation
- Degree of protection: IP20
- Protection class I



Electrical characteristics	Power	45,5W (350mA) - 52W (400mA) - 58.5W (450mA) - 65W (500mA)
	Voltage 50-60 Hz (V)	220V - 240V
	Main current mA	335mA - 305mA
	Inrush current A / μ s	23A / 300A
	Current output DC mA (\pm 5%)	350mA - 400mA - 450mA - 500mA
	Voltage output DC (min-max “V”)	40-130V
	THD %	<5%
	Efficiency at full load % (230V)	>94%
Ripple 100 Hz	<3%	
Maximum ratings	Ambient temperature range °C min.	-25 °C
	Ambient temperature range °C max.	+50 °C
	Operation humidity range % min.	5%
	Operation humidity range % max.	60%
	Storage temperature range °C min.	-40 °C
	Ambient temperature range °C max.	+85 °C
	Storage humidity range % min.	5%
	Storage humidity range % max.	95%
	Max. operation temperature at t_c point °C	+80 °C
	Degree of protection	IP20
Expected service life time	Operation current Max.	80°C - 70°C
	Operation current hrs.	50,000h - 100,000h
Dimming	Dimmable	no
	DALI power supply integrated	no
	Min. dimming level	100%
	Max. dimming level	100%
Other	Dimension	230x30x21mm
	Casing shape	M6.2
	Weight	151g
	Guarantee	5 years



Measurements:



Diagramme:



DIP switch settings

Pin 1	Pin 2	Current (mA)
OFF	OFF	350
ON	OFF	400
OFF	ON	450
ON	ON	500

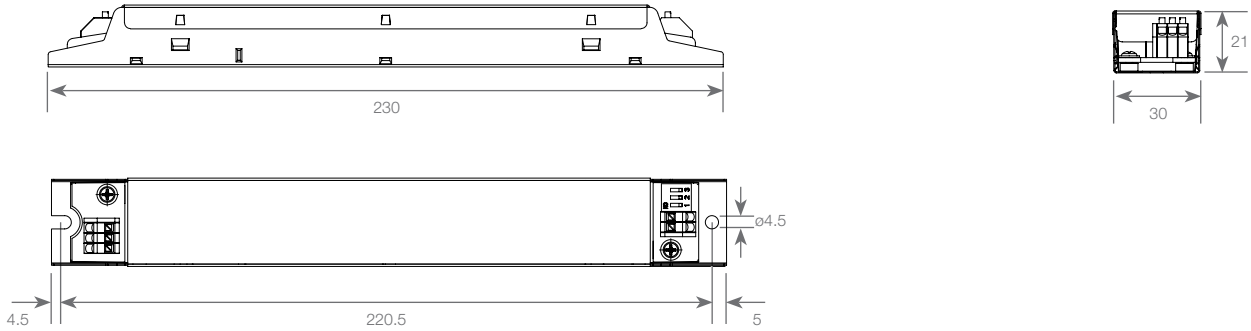
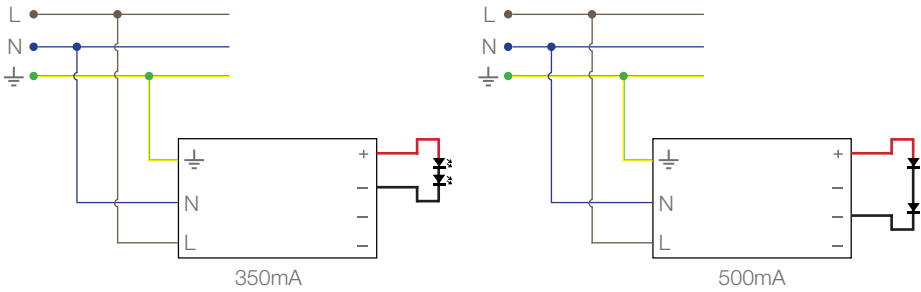
Type performance graphs / Type EDXe

Working area

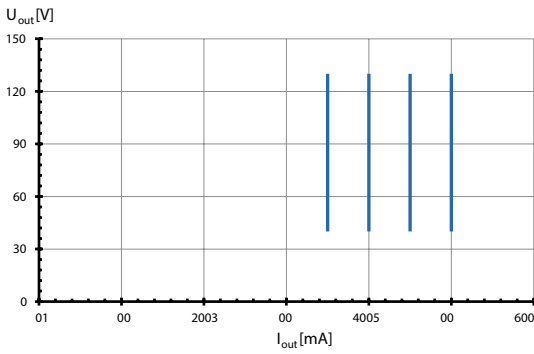

Efficiency

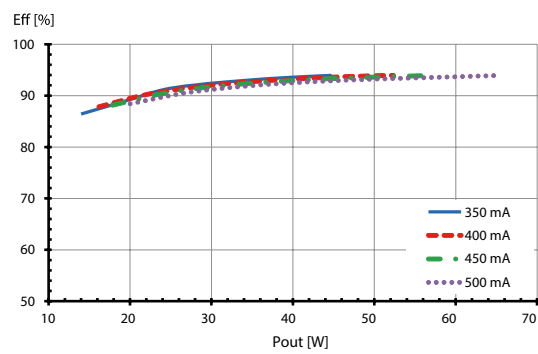

Power factor

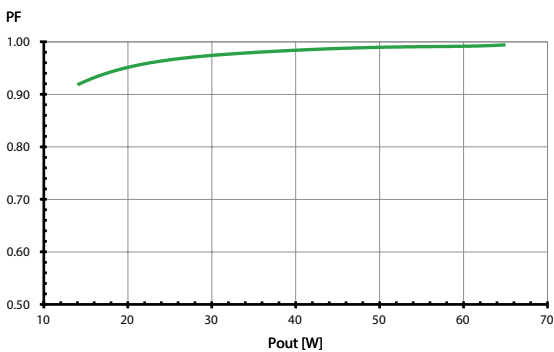

Total harmonic factor (THD)

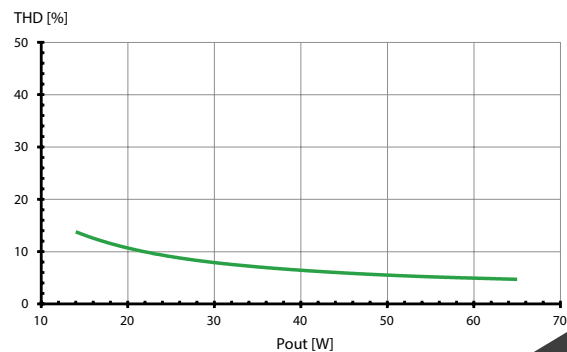

Assembly and Safety Information

Applied standards:

- EN 61347-1
- EN 61347-2-13
- EN 61547
- EN 61000-3-2
- EN 62384
- EN 55015

Safety functions

- **Transient main peaks protection:** values are in compliance with EN 61547 (interference immunity). Surges between L/N: up to 1 kV. Surges between L/N-PE: up to 2 kV.
- **Short-circuit protection:** the control gear is protected against permanent short-circuit with automatic restart function.
- **Overload protection:** the control gear only works in range of rated output power and voltage problemfree. Please check before switch-on main power supply that the selected LED load is suitable (see Electrical Characteristics on data sheet).
- **No load operation:** the control gear is protected against no load operation (open load).
- If any of the above mentioned safety functions will be triggered, disconnect the control gear from the power supply then find and eliminate the cause of the problem.

Mechanical mounting:

- **Mounting position:**
 - Built-in: any position inside a luminaire is allowed.
 - Independent application: led drivers are allowed to use for independent applicatons.
- **Mounting location:**
 - led drivers are designed for integration into luminaires or aomparable devices.
 - Installation in outdoor luminaires: degree of protection for luminaire with water protection rate ≥ 4 (e.g. IP54 required).
- **Degree of protection:** IP20
- **Clearance:** min. 0.10m from walls, ceilings and insulation.
- **Surface:** solid and plane surface for optimum heat dissipation required.
- **Heat transfer:**
 - If the led drivers is destined for installation in a luminaire. Sufficient heat transfer must be ensured between the led driver and the luminaire casing.
 - Led drivers should be mounted with the greatest possible clearance to heat soucrs. During operation, the temperature measure at the led driver's t_c point must not exceed the specified maximum value.
- **Fastening:** using M4 screws in the designated holes.

Electrical installation:

- **Connection terminals:** push-in terminals for rigid or flexible conductors with a section od 0.5 - 1.5mm².
- **Stripped length:** 8-9mm.
- **Wiring:** the main conductor within the luminaire must be kept short (to reduce the induction of interference). Main and lamp conductors must be kept separate and if possible should not be laid in parallel to one another.
- **Polarity:** please ensure the correct polarity of the leads prior to commissioning. Reversed polarity can destroy the modules.
- **Secondary load:** the sum of forward voltages of led loads has to be the tolerance tolerances which are mentioned in the Electrical Characteristics on the data sheet.

Product labels:

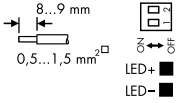
INPUT Un=220...240 V~ IN = 335...305 mA fn = 50/60 Hz λ = 0,92C...0,98	 Vossloh-Schwabe Deutschland GmbH Stuttgarter Straße 61/1, 73614 Schorndorf Electronic Converter for LED LED 控制装置 Type ECXe 500.620 Ref.-No. 187327 Made in China	OUTPUT ---																											
		<table border="1"> <thead> <tr> <th>Pin1</th> <th>Pin2</th> <th>Irated(mA)</th> <th>Prated(W)</th> <th>Urated(V)</th> <th>Uout(V)</th> </tr> </thead> <tbody> <tr> <td>OFF</td> <td>OFF</td> <td>350</td> <td>45,5</td> <td>40...130</td> <td rowspan="4"><250</td> </tr> <tr> <td>ON</td> <td>OFF</td> <td>400</td> <td>52</td> <td>40...130</td> </tr> <tr> <td>OFF</td> <td>ON</td> <td>450</td> <td>58,5</td> <td>40...130</td> </tr> <tr> <td>ON</td> <td>ON</td> <td>500</td> <td>63</td> <td>40...130</td> </tr> </tbody> </table>	Pin1	Pin2	Irated(mA)	Prated(W)		Urated(V)	Uout(V)	OFF	OFF	350	45,5	40...130	<250	ON	OFF	400	52	40...130	OFF	ON	450	58,5	40...130	ON	ON	500	63
Pin1	Pin2	Irated(mA)	Prated(W)	Urated(V)	Uout(V)																								
OFF	OFF	350	45,5	40...130	<250																								
ON	OFF	400	52	40...130																									
OFF	ON	450	58,5	40...130																									
ON	ON	500	63	40...130																									